



RoHS
Compliant
2002/95/EC



REV.	ECN.	NO.	APPD.

DIMENSIONS

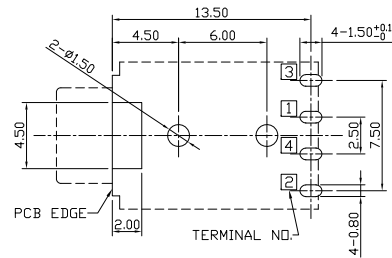
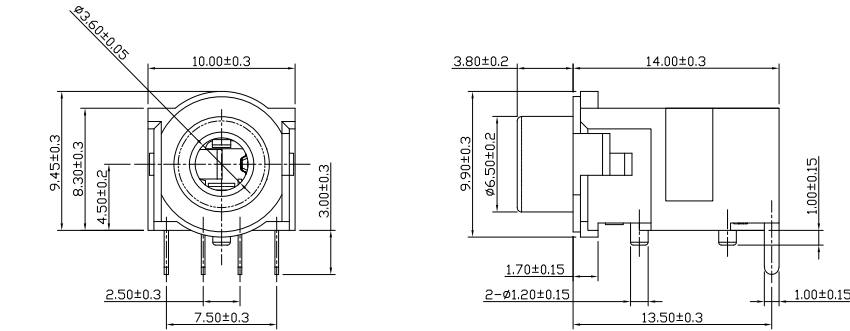

PCB HOLES(BOTTOM VIEW) t=1.6mm
NOTE:GENERAL TOLERANCE:±0.05mm

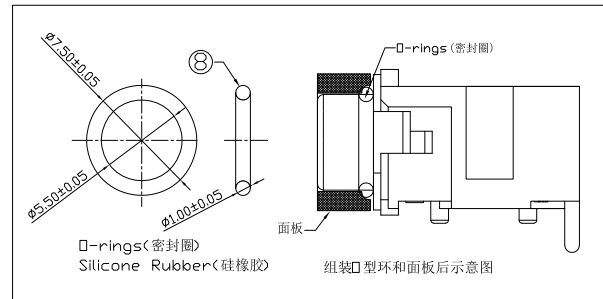
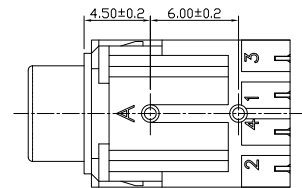

○: ITEM NO. □: TERMINAL NO.

MODEL CODE:

PJB0-3130B-M PB BK S 00 3

(1) (2) (3) (4) (5) (6) (7)

- (1):Series No.
- (2):Schematic option:M
- (3):Material of housing:
PB=PBT
- (4):Housing color:
BK=Black (Standard)
- (5):Terminal plating:
S=Silver(Ag 8u")
- (6):Special option:
00=No special option
- (7):Packing mode:
3=Plastic box packing
4=Bag packing

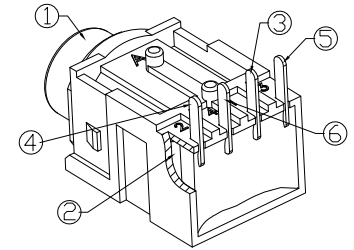

SPECIFICATION:

- 1.Rating :DC 30V 0.5A.
- 2.Contact resistance :≤30mΩ
After life test:≤50mΩ
- 3.Insulation resistance : ≥100MΩ (500VDC).
After life test:≥50MΩ
- 4.Withstand voltage :500VAC.
- 5.Insertion and extraction force:3N~30N.
- 6.life test :5000cycles min.
- 7.Operation temperature range:-20℃~70℃.
- 8.Preservative temperature range:-40℃~85℃.
- 9.Ingress protection:IP-X7.

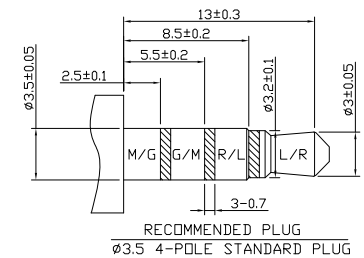
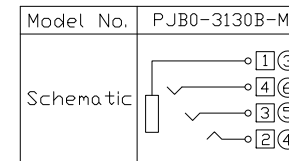

NO.	PARTS	MATERIAL	Q'TY	FINISHING
⑥	Ring spring B	④ Phosphor bronze t=0.25	1	Ag:8u"Min,Ni:40u"Min
⑤	Ring spring A	③ Phosphor bronze t=0.25	1	Ag:8u"Min,Ni:40u"Min
④	Tip spring	② Phosphor bronze t=0.30	1	Ag:8u"Min,Ni:40u"Min
③	Earth spring	① Phosphor bronze t=0.25	1	Ag:8u"Min,Ni:40u"Min
②	Cover	PA66 UL94-HB	1	Black
①	Housing	PBT(4815) UL94V-0	1	Black

TOLERANCE	ANGLES	UNITS
.X ±0.38	.X' ±5'	mm
.XX ±0.30	.X' ±3'	MAT'L
.XXX ±0.15	.XX' ±2'	SEE NOTE
		FINISH
		SEE NOTE
		Q'TY

雅安科技有限公司 ACCURATE INNOTECH INC.			
TITLE: WATERPROOF DIP 3.5MM PHONE JACK		PART NO.: PJB0-3130B	
DR: <i>Ricky</i> 2026/05/13		DWG NO.: AB0-3130B	
CHKD: <i>Ricky</i> 2026/05/13		SCALE	SHEET
APPD:		1:1	1/1
		REV.	CUSTOMER
		A	DRAWING

THESE DRAWINGS AND SPECIFICATIONS ARE THE PROPERTY OF ACCURATE INNOTECH INC AND SHALL NOT BE REPRODUCED, COPIED OR USED IN ANY MANNER WITHOUT THE PRIOR WRITTEN CONSENT OF ACCURATE INNOTECH INC.