

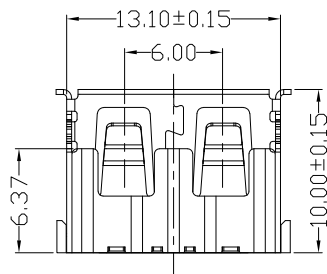

RoHS
Compliant
2002/95/EC

REV.	ECN.	NO.	APPD.

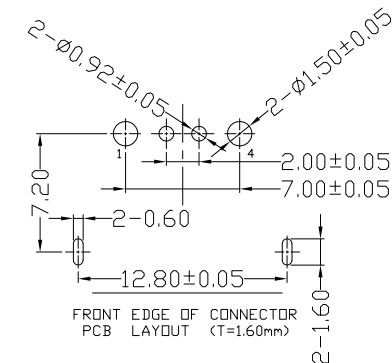
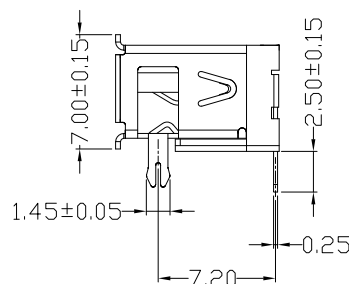
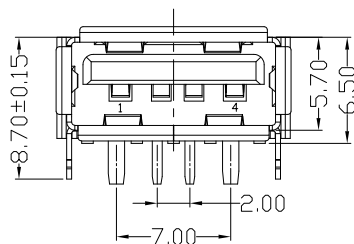
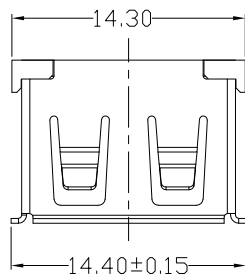

NOTES:

1.ELECTRICAL:

- 1)VOLTAGE CURRENT RATING: 5AMP,30V DC;
- 2)INSULATION RESISTANCE: 100MΩ MIN;
- 3)CONTACT RESISTANCE: 30mΩ MAX;
- 4)WITHSTANDING VOLTAGE: 100V AC FOR 1MINUTE;
- 5)OPERATING TEMPERATURE: -55°C TO +85°C.

2.MECHANICAL:

- 1)MATING FORCE: 35N MAX.
- 2)UNMATING FORCE: 10N MIN.

3.DIMENSIONS MARKED "▼"

TO BE CHECKED BY Q.C & IPQC.

4.PART NO.

USAF-042N-1*RJ557

- W:WHITE
- B:BLACK
- 1:PBT
- 2:PA6T
- 3:PA9T
- 4:LCP

2Au 3U"

Bill of materials:

NO	PARTS	MATERIAL	QTY	FINISHING	TOLERANCES	ANGLES	UNITS	MAT'L	FINISH	Q'TY	APPD:	SCALE	SHEET	REV.	CUSTOMER DRAWING
6					.X	±0.38	mm		SEE NOTE			1:1	1/1	B	
5					.XX	±0.25			SEE NOTE						
4					.XXX	±0.10									
3	SHELL	COPPER ALLOY	1	PLATED NICKEL											
2	TERMINAL	COPPER ALLOY	4	PLATED GOLD/TIN											
1	HOUSING	PBT+30%GF	1												
<p>THESE DRAWINGS AND SPECIFICATIONS ARE THE PROPERTY OF ACCURATE INNOTECH INC AND SHALL NOT BE REPRODUCED, COPIED OR USED IN ANY MANNER WITHOUT THE PRIOR WRITTEN CONSENT OF ACCURATE INNOTECH INC.</p>															

雅安科技有限公司
ACCURATE INNOTECH INC.

TITLE:
USB AF 大电流 10.0 有边前
两脚鱼叉方弹 有耳正向插板

PART NO.:
USAF-04XN-1XRJ557

DR: Ricky 2026/03/17

DWG NO.:
AII-RJ557

CHKD: Ricky 2026/03/17

APPD:

SCALE SHEET REV. CUSTOMER DRAWING



RoHS
Compliant
2002/95/EC

REV.	ECN.	NO.	APPD.

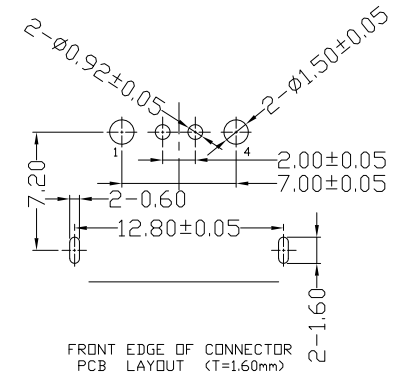
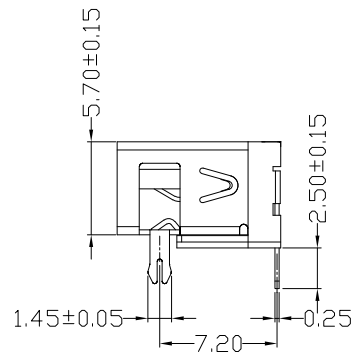
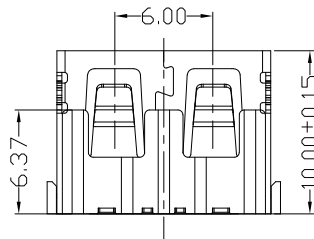
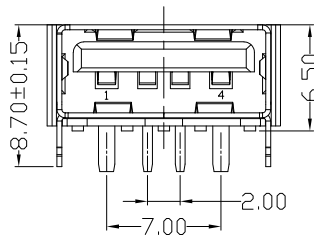
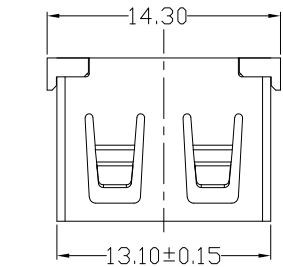

NOTES:

1.ELECTRICAL:

- 1)VOLTAGE CURRENT RATING: 5AMP,30V DC;
- 2)INSULATION RESISTANCE: 100MΩ MIN;
- 3)CONTACT RESISTANCE: 30mΩ MAX;
- 4)WITHSTANDING VOLTAGE: 100V AC FOR 1MINUTE;
- 5)OPERATING TEMPERATURE: -55°C TO +85°C.

2.MECHANICAL:

- 1)MATING FORCE: 35N MAX.
- 2)UNMATING FORCE: 10N MIN.

3.DIMENSIONS MARKED "▼"

TO BE CHECKED BY Q.C & IPQC.

4.PART NO.

USAF-042N-1*RJ560

- W:WHITE
- B:BLACK
- 2:Au 3U"
- 1:PBT
- 2:PA6T
- 3:PA9T
- 4:LCP

Bill of materials:

NO	PARTS	MATERIAL	QTY	FINISHING	TOLERANCES	ANGLES	UNITS	MAT'L	FINISH	Q'TY	APPD:	SCALE	SHEET	REV.	CUSTOMER DRAWING
6							mm								
5					.X	±0.38	±5'								
4					.XX	±0.25		SEE NOTE							
3	SHELL	COPPER ALLOY	1	PLATED NICKEL	.XXX	±0.10									
2	TERMINAL	COPPER ALLOY	4	PLATED GOLD/TIN	THESE DRAWINGS AND SPECIFICATIONS ARE THE PROPERTY OF ACCURATE INNOTECH INC AND SHALL NOT BE REPRODUCED, COPIED OR USED IN ANY MANNER WITHOUT THE PRIOR WRITTEN CONSENT OF ACCURATE INNOTECH INC.										
1	HOUSING	PBT+30%GF	1												

雅安科技有限公司
ACCURATE INNOTECH INC.

TITLE: USB AF 大电流 10.0 无边前
两脚鱼叉方弹 有耳正向插板

PART NO.: USAF-04XN-1XRJ560

DR: Ricky 2026/03/18

DWG NO.: AII-RJ560

CHKD: Ricky 2026/03/18

APPD:

SCALE: 1:1 SHEET: 1/1 REV.: B CUSTOMER DRAWING