

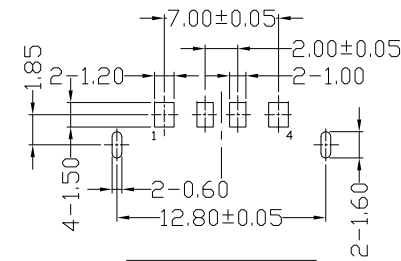

RoHS
Compliant
2002/95/EC

REV.	ECN.	NO.	APPD.

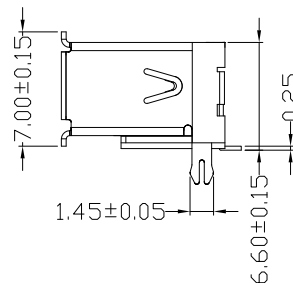
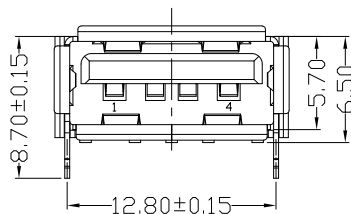
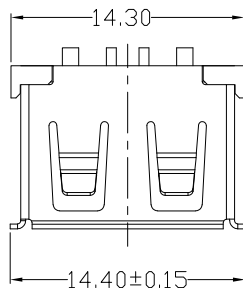

FRONT EDGE OF CONNECTOR
PCB LAYOUT (T=1.60mm)

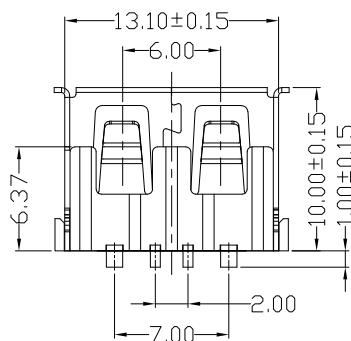

NOTES:

1.ELECTRICAL:

- 1)VOLTAGE CURRENT RATING: 5AMP,30V DC;
- 2)INSULATION RESISTANCE: 100MΩ MIN;
- 3)CONTACT RESISTANCE: 30mΩ MAX;
- 4)WITHSTANDING VOLTAGE: 100V AC FOR 1MINUTE;
- 5)OPERATING TEMPERATURE: -55°C TO +85°C.

2.MECHANICAL:

- 1)MATING FORCE: 35N MAX.
- 2)UNMATING FORCE: 10N MIN.

3.DIMENSIONS MARKED "▼"
TO BE CHECKED BY Q.C & IPQC.

4.PART NO.

USAF-042N-4*VJ535

- W:WHITE
- B:BLACK
- 1:PBT
- 2:PA6T
- 3:PA9T
- 4:LCP

Bill of materials:

NO	PARTS	MATERIAL	QTY	FINISHING	TOLERANCES	ANGLES	UNITS	雅安科技有限公司 ACCURATE INNOTECH INC.			
6							mm	TITLE: USB AF 大电流 10.0 有边后 两脚鱼叉方弹 有耳正向贴板 PART NO.: USAF-042N-4XVJ535 DR: Ricky 2026/03/20 DWG NO.: AII-VJ535 CHKD: Ricky 2026/03/20 SCALE: 1:1 SHEET: 1/1 REV: B CUSTOMER DRAWING			
5				.X	±0.38	±5'	MAT'L				
4				.XX	±0.25		SEE NOTE				
3	SHELL	COPPER ALLOY	1	PLATED NICKEL	.XXX	±0.10	FINISH				
2	TERMINAL	COPPER ALLOY	4	PLATED GOLD/TIN	THESE DRAWINGS AND SPECIFICATIONS ARE THE PROPERTY OF ACCURATE INNOTECH INC AND SHALL NOT BE REPRODUCED, COPIED OR USED IN ANY MANNER WITHOUT THE PRIOR WRITTEN CONSENT OF ACCURATE INNOTECH INC.			SEE NOTE			
1	HOUSING	LCP+30%GF	1	UL94V-0				Q'TY	APPD:		



RoHS
Compliant
2002/95/EC

REV.	ECN.	NO.	APPD.

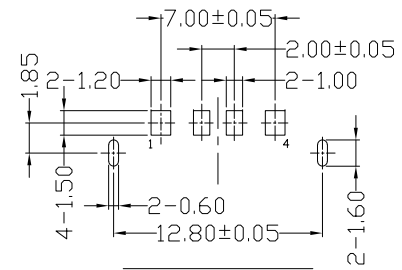
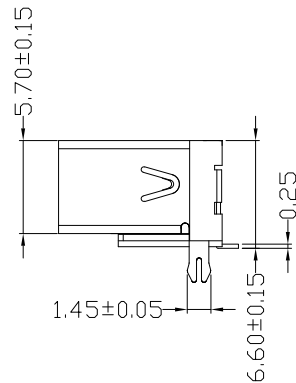
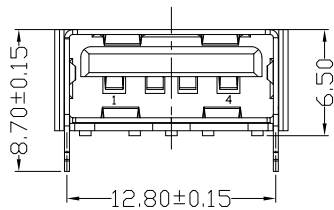
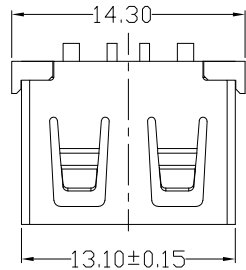

FRONT EDGE OF CONNECTOR
PCB LAYOUT (T=1.60mm)

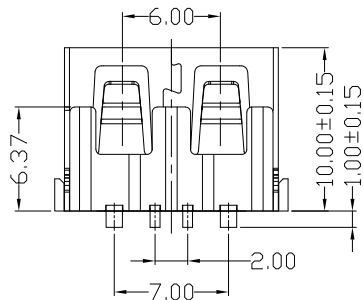

NOTES:

1.ELECTRICAL:

- 1)VOLTAGE CURRENT RATING: 5AMP,30V DC;
- 2)INSULATION RESISTANCE: 100MΩ MIN;
- 3)CONTACT RESISTANCE: 30mΩ MAX;
- 4)WITHSTANDING VOLTAGE: 100V AC FOR 1MINUTE;
- 5)OPERATING TEMPERATURE: -55°C TO +85°C.

2.MECHANICAL:

- 1)MATING FORCE: 35N MAX.
- 2)UNMATING FORCE: 10N MIN.

3.DIMENSIONS MARKED "▼"
TO BE CHECKED BY Q.C & IPQC.

4.PART NO.

USAF-042N-4*VJ538

- W:WHITE
- B:BLACK
- 1:PBT
- 2:PA6T
- 3:PA9T
- 4:LCP

Bill of materials:

NO	PARTS	MATERIAL	QTY	FINISHING	TOLERANCES	ANGLES	UNITS	MAT'L	FINISH	Q'TY	APPD:	SCALE	SHEET	REV.	CUSTOMER DRAWING		
6							mm				雅安科技有限公司 ACCURATE INNOTECH INC.	1:1	1/1	B	DRAWING		
5					.X ±0.38	±5'		SEE NOTE		TITLE: USB AF 大电流 10.0 无边后 两脚鱼叉方弹 有耳正向贴板						PART NO.:	USAF-042N-4XVJ538
4					.XX ±0.25			SEE NOTE		DR: Ricky 2026/03/21						DWG NO.:	AII-VJ538
3	SHELL	COPPER ALLOY	1	PLATED NICKEL	.XXX ±0.10					CHKD: Ricky 2026/03/21							
2	TERMINAL	COPPER ALLOY	4	PLATED GOLD/TIN						APPD:							
1	HOUSING	LCP+30%GF	1	UL94V-0													
<small>THESE DRAWINGS AND SPECIFICATIONS ARE THE PROPERTY OF ACCURATE INNOTECH INC AND SHALL NOT BE REPRODUCED, COPIED OR USED IN ANY MANNER WITHOUT THE PRIOR WRITTEN CONSENT OF ACCURATE INNOTECH INC.</small>																	